

Wedge-Bolt+ Screw Anchor

PRODUCT DESCRIPTION

The Wedge-Bolt+ anchor is a one piece, heavy duty screw anchor with a finished hex head. It is simple to install, easy to identify and fully removable. The Wedge-Bolt+ has features and benefits that make it well suited for many applications. The steel threads along the anchor body tap into the hole during installation to provide keyed engagement. Suitable base materials include normal-weight concrete, structural sand-light weight concrete and concrete over steel deck. The anchor is designed for consistent and reliable performance in cracked and uncracked concrete.

GENERAL APPLICATIONS AND USES

- Racking, shelving and material handling
- Support ledgers and temporary attachments
- Interior applications/low level corrosion environment
- Retrofits, repairs and maintenance
- Fencing and railing
- Seismic and wind loading

FEATURES AND BENEFITS

- + Consistent performance in high and low strength concrete
- + Anchor can be installed through standard fixture holes
- + Wedge-bit size is matched to the nominal anchor diameter
- + Diameter, length and identifying marking stamped on head of each anchor
- + Fast installation with a powered impact wrench
- + One-piece, finished head design eliminates improper assembly or missing components

APPROVALS AND LISTINGS

International Code Council, Evaluation Service (ICC-ES), ESR-2526
 Code compliant with the 2006 IBC, 2006 IRC, 2003 IBC, 2003 IRC and 1997 UBC
 Tested in accordance with ACI 355.2 and ICC-ES AC193 for use in structural concrete under the design provisions of ACI 318 (Strength Design method using Appendix D)
 Evaluated and qualified by an accredited independent testing laboratory for recognition in cracked and uncracked concrete including seismic and wind loading (Category 1 anchors)
 Evaluated and qualified by an accredited independent testing laboratory for reliability against brittle failure, e.g. hydrogen embrittlement

GUIDE SPECIFICATIONS

CSI Divisions: 03151-Concrete Anchoring and 05090-Metal Fastenings.
 Screw anchors shall be Wedge-Bolt+ as supplied by Powers Fasteners, Inc., Brewster, NY.
 Anchors shall be installed in accordance with published instructions and the Authority Having Jurisdiction.

MATERIAL SPECIFICATIONS

Anchor component	Specification
Anchor body and hex washer head	Case hardened low carbon steel
Plating	Zinc plating according to ASTM B 633, SC1, Type III (Fe/Zn 5) Minimum plating requirement for mild Service Condition

SECTION CONTENTS	Page No.
General Information	1
Material Specifications.....	1
Installation Specifications	2
Installation Instructions.....	3
Performance Data	4
Ordering Information	7



Wedge-Bolt+

ANCHOR MATERIALS

Zinc plated carbon steel body and hex washer head

ANCHOR SIZE RANGE (TYP.)

1/4" diameter (uncracked concrete only)
 3/8" diameter through 3/4" diameter

SUITABLE BASE MATERIALS

Normal-weight concrete
 Structural sand-lightweight concrete
 Concrete over steel deck



INSTALLATION SPECIFICATIONS

Installation Table for Wedge-Bolt+

Anchor Property/Setting Information	Notation	Units	Nominal Anchor Size					
			1/4"	3/8"	1/2"	5/8"	3/4"	
Nominal anchor diameter	d_o	in. (mm)	0.250 (6.4)	0.375 (9.5)	0.500 (12.7)	0.625 (15.9)	0.750 (19.1)	
Minimum diameter of hole clearance in fixture	d_h	in. (mm)	5/16 (7.9)	7/16 (11.1)	9/16 (14.3)	11/16 (17.5)	13/16 (20.6)	
Nominal drill bit diameter	d_{bit}	in.	1/4 Wedge-bit	3/8 Wedge-bit	1/2 Wedge-bit	5/8 Wedge-bit	3/4 Wedge-bit	
Wedge-bit tolerance range	-	in.	0.255 to 0.259	0.385 to 0.389	0.490 to 0.495	0.600 to 0.605	0.720 to 0.725	
Minimum nominal embedment depth	h_{nom}	in. (mm)	1-3/4 (44)	2-1/8 (54)	2-1/2 (64)	3-1/2 (89)	3-1/4 (83)	4-3/8 (111)
Effective embedment	h_{ef}	in. (mm)	1.100 (28)	1.426 (36)	1.652 (42)	2.502 (64)	2.146 (55)	3.102 (79)
Minimum hole depth ¹	h_o	in. (mm)	2 (51)	2-1/2 (64)	3 (76)	4 (102)	3-7/8 (98)	5 (127)
Minimum concrete member thickness ¹	h_{min}	in. (mm)	4 (102)	4 (102)	5 (127)	6 (152)	6 (152)	7 (178)
Minimum overall anchor length	l_{anch}	in. (mm)	2-1/4 (57)	2-1/2 (64)	3 (76)	4 (102)	4 (102)	5 (127)
Minimum edge distance ¹	c_{min}	in. (mm)	2-3/4 (70)	2-1/4 (57)	3 (76)	3 (76)	4 (102)	4 (102)
Minimum edge distance, close edge condition ²	c_{min}	in. (mm)	-	1-3/4 (44)	1-3/4 (44)	1-3/4 (44)	1-3/4 (44)	1-3/4 (44)
Minimum spacing distance ¹	s_{min}	in. (mm)	4 (102)	3 (76)	4 (102)	4 (102)	5 (127)	5 (127)
Critical edge distance ¹	c_{ac}	in. (mm)	2-3/4 (70)	3-1/4 (83)	3 (76)	4 (102)	4 (102)	5 (127)
Maximum impact wrench power (torque)	T_{screw}	ft.-lb. (N-m)	115 (156)	245 (332)	300 (407)	350 (475)	400 (542)	
Impact wrench socket size	-	in.	7/16	9/16	3/4	15/16	1-1/8	
Head height	-	in.	7/32	21/64	7/16	1/2	19/32	

- For installations through the soffit of steel deck into concrete, see the installation detail. Anchors in the lower flute may be installed with a maximum 1-inch offset in either direction from center of the flute. In addition, anchors shall have an axial spacing along the flute equal to the greater of $3h_{ef}$ or 1.5 times the flute width.
- For installations in concrete (excluding the soffit of steel deck) with the listed edge distance, the anchor spacing distance must be equal to or greater than $5h_{nom}$.

Wedge-Bolt+ Anchor Detail

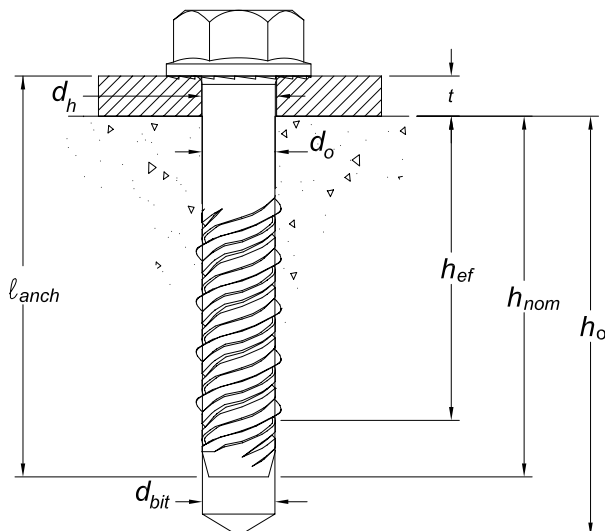

Hex Head Marking



Legend

Diameter and Length Identification Mark
'+' Symbol = Strength Design Compliant Anchor
(see ordering information)

Matched Tolerance System



Designed and tested as a system for consistency and reliability

INSTALLATION INSTRUCTIONS

Installation Instructions for Wedge-Bolt+

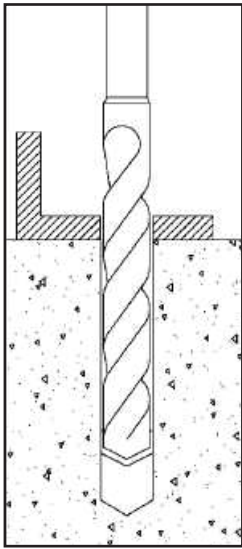

1.) Using the proper Wedge-bit size, drill a hole into the base material to the required depth. The tolerances of the carbide Wedge-bit used must meet the requirements of the published Wedge-bit range.

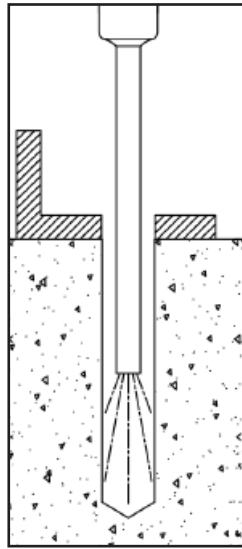

2.) Remove dust and debris from the hole.

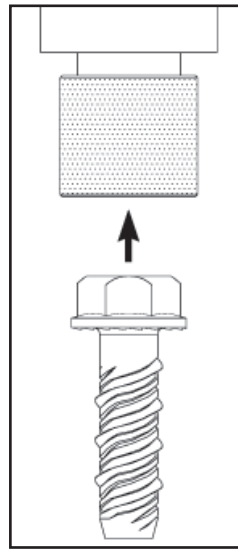

3.) Select a powered impact wrench that does not exceed the maximum torque, T_{screw} , for the selected anchor diameter. Attach an appropriate sized hex socket to the impact wrench. Mount the screw anchor head into the socket.

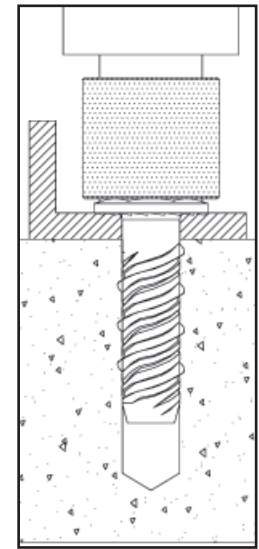

4.) Drive the anchor through the fixture and into the hole until the head of the anchor comes into contact with the fixture. The anchor should be snug after installation. Do not spin the hex socket off the anchor to disengage.

Installation Detail for Wedge-Bolt+ Installed Through Soffit of Steel Deck into Concrete

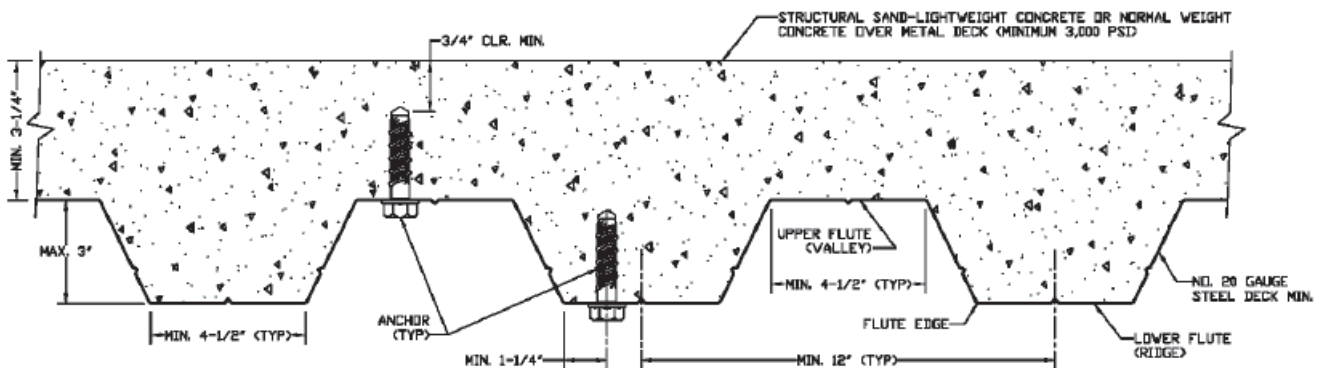

(d)

PERFORMANCE DATA

Tension Design Information (For use with load combinations taken from ACI 318 Section 9.2)^{1,2,3}

Design Characteristic	Notation	Units	Nominal Anchor Size						
			1/4"	3/8"	1/2"	5/8"	3/4"		
Anchor category	1, 2 or 3	-	1	1	1	1	1	1	
Nominal embedment depth	h_{nom}	in.	1-3/4	2-1/8	2-1/2	3-1/2	3-1/4	4-3/8	4-1/4
STEEL STRENGTH IN TENSION⁴									
Minimum specified ultimate strength	f_{uta}	ksi (N/mm ²)	100.0 (990)	100.0 (990)	100.0 (990)	100.0 (990)	100.0 (990)	100.0 (990)	100.0 (990)
Effective tensile stress area	A_{se}	in ² (mm ²)	0.044 (1.10)	0.103 (2.66)	0.168 (4.28)	0.168 (4.28)	0.249 (6.41)	0.371 (9.53)	0.371 (9.53)
Steel strength in tension	N_{sa}	lb (kN)	4,400 (19.6)	10,300 (45.8)	16,800 (74.7)	16,800 (74.7)	24,900 (110.7)	37,100 (164.9)	37,100 (164.9)
Reduction factor for steel strength ³	ϕ	-	0.65						
CONCRETE BREAKOUT STRENGTH IN TENSION⁸									
Effective embedment	h_{ef}	in. (mm)	1.100 (28)	1.426 (36)	1.652 (42)	2.502 (64)	2.146 (54)	3.102 (79)	2.909 (74)
Effectiveness factor for uncracked concrete	k_{uncr}	-	24	24	24	24	24	24	24
Effectiveness factor for cracked concrete	k_{cr}	-	Not Applicable	17	17	17	17	17	17
Modification factor for cracked and uncracked concrete ⁵	$\psi_{c,N}$	-	1.0 See note 5	1.0 See note 5	1.0 See note 5	1.0 See note 5	1.0 See note 5	1.0 See note 5	1.0 See note 5
Critical edge distance	c_{ac}	in. (mm)	2-3/4 (70)	3-1/4 (83)	3 (76)	4 (102)	4 (102)	5 (127)	6 (152)
Reduction factor for concrete breakout strength ³	ϕ	-	0.65 (Condition B)						
PULLOUT STRENGTH IN TENSION (NON-SEISMIC APPLICATIONS)⁸									
Characteristic pullout strength, uncracked concrete (2,500 psi) ⁶	$N_{p,uncr}$	lb (kN)	See note 7	See note 7	See note 7	See note 7	See note 7	See note 7	See note 7
Characteristic pullout strength, cracked concrete (2,500 psi) ⁶	$N_{p,cr}$	lb (kN)	No Data	See note 7	See note 7	2,965 (13.2)	3,085 (13.7)	4,290 (19.1)	See note 7
Reduction factor for pullout strength ³	ϕ	-	0.65 (Condition B)						
PULLOUT STRENGTH IN TENSION FOR SEISMIC APPLICATIONS⁸									
Characteristic pullout strength, seismic ^{6,9}	N_{eq}	lb (kN)	No Data	1,085 (4.8)	1,350 (6.0)	2,520 (11.2)	3,085 (13.7)	4,290 (19.1)	4,270 (19.0)
Reduction factor for pullout strength ³	ϕ	-	0.65 (Condition B)						
PULLOUT STRENGTH IN TENSION FOR STRUCTURAL SAND-LIGHTWEIGHT AND NORMAL-WEIGHT CONCRETE OVER STEEL DECK									
Characteristic pullout strength, uncracked concrete over steel deck ¹⁰	$N_{p,deck,uncr}$	lb (kN)	No Data	2,010 (8.9)	2,480 (11.0)	2,215 (9.8)	No Data	No Data	No Data
Characteristic pullout strength, cracked concrete over steel deck ¹⁰	$N_{p,deck,cr}$	lb (kN)	No Data	1,425 (6.3)	1,755 (7.8)	1,570 (7.0)	No Data	No Data	No Data
Reduction factor for pullout strength ³	ϕ	-	0.65 (Condition B)						

- The data in this table is intended to be used with the design provisions of ACI 318 Appendix D; for anchors resisting seismic load combinations the additional requirements of Section D.3.3 shall apply.
- Installation must comply with published instructions and details.
- All values of ϕ were determined from the load combinations of ACI 318 Section 9.2. If the load combinations of Appendix C are used, the appropriate value of ϕ must be determined in accordance with ACI 318 Section D.4.5. For reinforcement that meets ACI 318 Appendix D requirements for Condition A, see ACI 318 Section D.4.4 for the appropriate ϕ factor.
- The Wedge-Bolt+ is considered a brittle steel element as defined by ACI 318 Section D.1.
- For all design cases use $\psi_{c,N} = 1.0$. Select appropriate effectiveness factor for cracked concrete (k_{cr}) or uncracked concrete (k_{uncr}).
- For all design cases use $\psi_{c,P} = 1.0$. For concrete compressive strength greater than 2,500 psi, $N_{pn} = (\text{pullout strength value from table}) * (\text{specified concrete compressive strength} / 2500)^{0.5}$.
- Pullout strength will not control design of indicated anchors. Do not calculate pullout strength for indicated anchor size and embedment.
- Reported values for characteristic pullout strength in tension for seismic applications are based on test results per ACI 355.2, Section 9.5.
- Anchors are permitted to be used in structural sand-lightweight concrete provided that N_b and N_{pn} are multiplied by a factor of 0.60 (not required for steel deck).
- Values for $N_{p,deck}$ are for structural sand-lightweight concrete ($f'_{c,min} = 3,000$ psi) and additional lightweight concrete reduction factors need not be applied. In addition, evaluation for the concrete breakout capacity in accordance with ACI 318 Section D.5.2 is not required for anchors installed in the flute (soffit).

PERFORMANCE DATA
Shear Design Information (For use with load combinations taken from ACI 318 Section 9.2)^{1,2,3}

Design Characteristic	Notation	Units	Nominal Anchor Size						
			1/4"	3/8"	1/2"	5/8"	3/4"		
Anchor category	1, 2 or 3	-	1	1	1	1	1		
Nominal embedment depth	h_{nom}	in.	1-3/4	2-1/8	2-1/2	3-1/2	3-1/4	4-3/8	4-1/4
STEEL STRENGTH IN SHEAR⁴									
Steel strength in shear ⁵	V_{sa}	lb (kN)	2,475 (11.0)	4,830 (21.5)	7,970 (35.4)	11,990 (53.3)	19,350 (86.1)		
Reduction factor for steel strength ³	ϕ	-	0.60						
CONCRETE BREAKOUT STRENGTH IN SHEAR⁶									
Load bearing length of anchor (h_{ef} or $8d_o$, whichever is less)	l_e	in. (mm)	1.100 (28)	1.426 (36)	1.652 (42)	2.502 (64)	2.146 (54)	3.102 (79)	2.909 (74)
Nominal anchor diameter	d_o	in. (mm)	0.250 (6.4)	0.375 (9.5)	0.500 (12.7)	0.625 (15.9)	0.750 (19.1)		
Reduction factor for concrete breakout strength ³	ϕ	-	0.70 (Condition B)						
CONCRETE PRYOUT STRENGTH IN SHEAR⁶									
Coefficient for prout strength (1.0 for $h_{ef} < 2.5$ in., 2.0 for $h_{ef} \geq 2.5$ in.)	k_{cp}	-	1.0	1.0	1.0	2.0	1.0	2.0	2.0
Effective embedment	h_{ef}	in. (mm)	1.100 (28)	1.426 (36)	1.652 (42)	2.502 (64)	2.146 (54)	3.102 (79)	2.909 (74)
Reduction factor for prout strength ³	ϕ	-	0.70 (Condition B)						
STEEL STRENGTH IN SHEAR FOR SEISMIC APPLICATIONS⁶									
Steel strength in shear, seismic ⁷	V_{eq}	lb (kN)	No Data	3,670 (16.3)	7,980 (35.5)	11,990 (53.3)	12,970 (57.7)		
Reduction factor for steel strength in shear for seismic ³	ϕ	-	0.60						
STEEL STRENGTH IN SHEAR FOR STRUCTURAL SAND-LIGHTWEIGHT AND NORMAL-WEIGHT CONCRETE OVER STEEL DECK^{8,9}									
Steel strength in shear, concrete over steel deck ⁸	$V_{sa,deck}$	lb (kN)	No Data	1,640 (7.3)	3,090 (13.7)	No Data	No Data		
Reduction factor for steel strength in shear for steel deck ³	ϕ	-	0.60						

- The data in this table is intended to be used with the design provisions of ACI 318 Appendix D; for anchors resisting seismic load combinations the additional requirements of Section D.3.3 shall apply.
- Installation must comply with published instructions and details.
- All values of ϕ were determined from the load combinations of ACI 318 Section 9.2. If the load combinations of Appendix C are used, the appropriate value of ϕ must be determined in accordance with ACI 318 Section D.4.5. For reinforcement that meets ACI 318 Appendix D requirements for Condition A, see ACI 318 Section D.4.4 for the appropriate ϕ factor.
- The Wedge-Bolt+ is considered a brittle steel element as defined by ACI 318 Section D.1.
- Reported values for steel strength in shear are based on test results per ACI 355.2, Section 9.4 and shall be used for design. These reported values may be lower than calculated results using equation D-20 in ACI 318-05 Section D.6.1.2 and D-18 in ACI 318-02, Section D.6.1.2.
- Anchors are permitted to be used in structural sand-lightweight concrete provided that V_b and V_{cp} are multiplied by a factor of 0.60 (not required for steel deck).
- Reported values for steel strength in shear for seismic applications are based on test results per ACI 355.2, Section 9.6.
- Values for $V_{sa,deck}$ are for structural sand-lightweight concrete ($f'_{c, min} = 3,000$ psi) and additional lightweight concrete reduction factors need not be applied. In addition, evaluation for the concrete breakout capacity in accordance with ACI 318 Section D.6.2 and the prout capacity in accordance with Section D.6.3 are not required for anchors installed in the flute (soffit).
- Shear loads for anchors installed through steel deck into concrete may be applied in any direction.

(d)

Factored Design Strength (ϕN_n and ϕV_n) Calculated in Accordance with ACI 318 Appendix D:

- Tabular values are provided for illustration and are applicable for single anchors installed in normal-weight concrete with minimum slab thickness, $h_a = h_{min}$, and with the following conditions:
 - c_{a1} is greater than or equal to the critical edge distance, c_{ac} (table values based on $c_{a1} = c_{ac}$).
 - c_{a2} is greater than or equal to $1.5 c_{a1}$.
- Calculations were performed according to ACI 318-05 Appendix D. The load level corresponding to the controlling failure mode is listed. (e.g. For *tension*: steel, concrete breakout and pullout; For *shear*: steel, concrete breakout and pryout). Furthermore, the capacities for concrete breakout strength in tension and pryout strength in shear are calculated using the effective embedment values, h_{ef} , for the selected anchors as noted in the design information tables. Please also reference the installation specifications for more information.
- Strength reduction factors (ϕ) were based on ACI 318 Section 9.2 for load combinations. Condition B is assumed.
- Tabular values are permitted for static loads only, seismic loading is not permitted with these tables.
- For designs that include combined tension and shear, the interaction of tension and shear loads must be calculated in accordance with ACI 318 Appendix D.
- Interpolation is not permitted to be used with the tabular values. For intermediate base material compressive strengths please see ACI 318 Appendix D. For other design conditions including seismic considerations please see ACI 318 Appendix D.

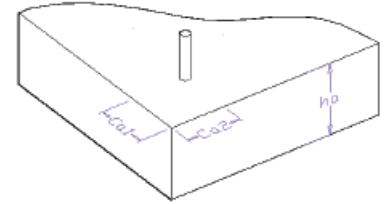

Tension and Shear Factored Design Strength for Wedge-Bolt+ in Cracked Concrete

Nominal Anchor Size (in.)	Nominal Embed. h_{nom} (in.)	Minimum Concrete Compressive Strength, $f'c$ (psi)									
		2,500		3,000		4,000		6,000		8,000	
		ϕN_n Tension (lbs.)	ϕV_n Shear (lbs.)	ϕN_n Tension (lbs.)	ϕV_n Shear (lbs.)	ϕN_n Tension (lbs.)	ϕV_n Shear (lbs.)	ϕN_n Tension (lbs.)	ϕV_n Shear (lbs.)	ϕN_n Tension (lbs.)	ϕV_n Shear (lbs.)
1/4	1-3/4	-	-	-	-	-	-	-	-	-	-
3/8	2-1/8	940	940	1,030	1,030	1,190	1,190	1,460	1,460	1,685	1,685
1/2	2-1/2	1,175	1,265	1,285	1,385	1,485	1,600	1,815	1,955	2,100	2,260
	3-1/2	1,925	1,915	2,110	2,095	2,440	2,420	2,985	2,965	3,450	3,420
5/8	3-1/4	1,735	1,870	1,905	2,050	2,195	2,365	2,690	2,900	3,105	3,345
	4-3/8	2,790	2,785	3,055	3,050	3,525	3,520	4,320	4,325	4,990	4,980
3/4	4-1/4	2,740	3,180	3,005	3,485	3,465	4,025	4,245	4,925	4,905	5,690

Tension and Shear Factored Design Strength for Wedge-Bolt+ in Uncracked Concrete

Nominal Anchor Size (in.)	Nominal Embed. h_{nom} (in.)	Minimum Concrete Compressive Strength, $f'c$ (psi)									
		2,500		3,000		4,000		6,000		8,000	
		ϕN_n Tension (lbs.)	ϕV_n Shear (lbs.)	ϕN_n Tension (lbs.)	ϕV_n Shear (lbs.)	ϕN_n Tension (lbs.)	ϕV_n Shear (lbs.)	ϕN_n Tension (lbs.)	ϕV_n Shear (lbs.)	ϕN_n Tension (lbs.)	ϕV_n Shear (lbs.)
1/4	1-3/4	900	970	985	1,060	1,140	1,225	1,395	1,485	1,610	1,485
3/8	2-1/8	1,330	1,320	1,455	1,445	1,680	1,670	2,060	2,045	2,375	2,360
1/2	2-1/2	1,655	1,780	1,815	1,950	2,095	2,250	2,565	2,755	2,965	3,180
	3-1/2	3,085	2,680	3,380	2,935	3,905	3,385	4,780	4,150	5,520	4,780
5/8	3-1/4	2,450	2,640	2,685	2,895	3,100	3,340	3,800	4,090	4,385	4,725
	4-3/8	4,260	3,900	4,670	4,270	5,390	4,930	6,600	6,040	7,625	6,975
3/4	4-1/4	3,870	4,455	4,240	4,880	4,895	5,635	5,995	6,900	6,925	7,965

Legend

- Steel Strength Controls
- Concrete Breakout Strength Controls
- Anchor Pullout/Pryout Strength Controls

ORDERING INFORMATION
Wedge-Bolt+ Screw Anchor (Carbon Steel with Blue Tip)

Cat. No.	Anchor Size	Minimum Nominal Embed.	Box Qty.	Carton Qty.	Wt./100 (lbs)
7204SD	1/4" x 1-1/4"	-	100	600	3
7206SD	1/4" x 1-3/4"	-	100	600	4
7208SD	1/4" x 2-1/4"	1-3/4"	100	600	4
7210SD	1/4" x 3"	1-3/4"	100	500	5
7220SD	3/8" x 1-3/4"	-	50	300	9
7222SD	3/8" x 2-1/2"	2-1/8"	50	300	10
7224SD	3/8" x 3"	2-1/8"	50	250	12
7226SD	3/8" x 4"	2-1/8"	50	250	15
7228SD	3/8" x 5"	2-1/8"	50	250	18
7230SD	3/8" x 6"	2-1/8"	50	150	22
7240SD	1/2" x 2"	-	50	200	15
7242SD	1/2" x 2-1/2"	-	50	200	17
7244SD	1/2" x 3"	2-1/2"	50	150	20
7246SD	1/2" x 4"	2-1/2"	50	150	26
7248SD	1/2" x 5"	2-1/2"	25	100	30
7250SD	1/2" x 6"	2-1/2"	25	75	35
7268SD	1/2" x 6-1/2"	2-1/2"	25	75	37
7252SD	1/2" x 8"	2-1/2"	25	75	43
7260SD	5/8" x 3"	2-1/2"	25	100	35
7262SD	5/8" x 4"	3-1/4"	25	100	41
7264SD	5/8" x 5"	3-1/4"	25	75	48
7266SD	5/8" x 6"	3-1/4"	25	75	54
7270SD	5/8" x 8"	3-1/4"	25	75	65
7280SD	3/4" x 3"	-	20	60	50
7282SD	3/4" x 4"	-	20	60	60
7284SD	3/4" x 5"	4-1/4"	20	60	71
7286SD	3/4" x 6"	4-1/4"	20	60	81
7288SD	3/4" x 8"	4-1/4"	10	40	103
7290SD	3/4" x 10"	4-1/4"	10	30	100



Shaded catalogue numbers denote sizes which are less than the minimum standard anchor length for strength design. The published size includes the diameter and length of the anchor measured from under the head. Wedge-Bolt+ is marked with a blue tip and must be installed with a matched tolerance Wedge-bit.

ORDERING INFORMATION

Wedge-bits

Cat. No.	Wedge-bit Description	Usable Length	Tube Qty.	Carton Qty.
01312	SDS 1/4" x 4"	2"	1	250
01314	SDS 1/4" x 6"	4"	1	100
01316	SDS 3/8" x 6"	4"	1	200
01318	SDS 3/8" x 8"	6"	1	100
01319	SDS 3/8" x 18"	16"	1	50
01332	SDS 3/8" x 12"	10"	1	50
01320	SDS 1/2" x 6"	4"	1	150
01322	SDS 1/2" x 10"	8"	1	50
01334	SDS 1/2" x 12"	10"	1	50
01335	SDS 1/2" x 18"	16"	1	50
01324	SDS 5/8" x 8"	6"	1	75
01326	SDS 5/8" x 12"	10"	1	75
01336	SDS 5/8" x 18"	16"	1	50
01328	SDS 3/4" x 8"	6"	1	100
01330	SDS 3/4" x 12"	10"	1	50
01340	Spline 1/2" x 13"	8"	1	20
01342	Spline 1/2" x 16"	11"	1	-
01344	Spline 5/8" x 13"	8"	1	20
01348	Spline 3/4" x 13"	8"	1	20
01354	SDS-Max 1/2" x 13"	8"	1	20
01356	SDS-Max 5/8" x 13"	8"	1	20
01358	SDS-Max 3/4" x 13"	8"	1	20
01370	HD Straight Shank 1/4" x 4"	2-1/2"	1	100
01372	HD Straight Shank 1/4" x 6"	4"	1	-
01380	HD Straight Shank 3/8" x 6"	4"	1	-
01384	HD Straight Shank 3/8" x 13"	11"	1	-
01390	HD Straight Shank 1/2" x 6"	4"	1	-
01394	HD Straight Shank 1/2" x 13"	11"	1	50
01396	HD Straight Shank 5/8" x 13"	11"	1	-
01397	HD Straight Shank 3/4" x 13"	11"	1	-



Installation Accessories

Cat. No.	Description	Box Qty.
08280	Hand pump / dust blower	1

