

# KM Spiral Housing Rings

**Internal, Medium Duty**  
 These rings offer the greatest economy in price and size. They are able to handle approximately twice the thrust capacity of the KL series, and to be produced to military specifications if needed.

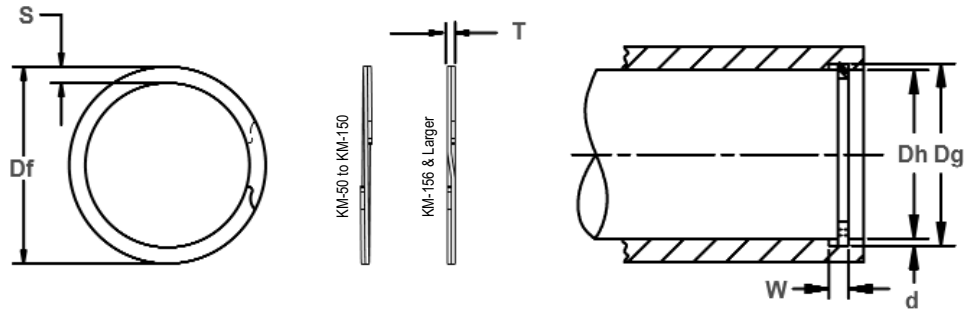

Free Diameter & Ring Measurements

Housing Diameter & Groove Dimensions

RING NO.	HOUSING DIAMETER	GROOVE SIZE					RING SIZE						THRUST LOAD (lbs.)	
		DIAMETER		WIDTH		DEPTH	FREE DIAMETER		THICKNESS		SECTION		RING Safety factor of 3	GROOVE Safety factor of 2
		(In.)	Dg	Tol.	W	Tol.	d	Df	Tol.	T	Tol.	S	Tol.	
KM-50	.500	.526		.030		.013	.532		.025		.045		2000	460
KM-51	.512	.538		.030		.013	.544		.025		.045		2050	470
KM-53	.531	.557		.030		.013	.564		.025		.045		2130	490
KM-56	.562	.588		.030		.013	.594		.025		.045		2250	520
KM-59	.594	.619	+ .002	.030		.013	.626		.025		.045		2380	550
KM-62	.625	.651	- .002	.030		.013	.658		.025		.045		2500	570
KM-65	.656	.682		.030		.013	.689		.025		.045		2630	600
KM-68	.687	.713		.030		.013	.720		.025		.045		2750	630
KM-71	.718	.744		.030		.013	.751		.025		.045		2870	660
KM-75	.750	.782		.036		.016	.790		.031		.065		3360	850
KM-77	.777	.808		.036		.016	.817	+ .013	.031		.065		3480	880
KM-78	.781	.812		.036	+ .003	.016	.821	- .000	.031		.065		3500	880
KM-81	.812	.843		.036	- .000	.016	.853		.031		.065		3640	920
KM-84	.843	.880		.036		.019	.889		.031		.065		3780	1130
KM-86	.866	.903		.036		.019	.913		.031		.065		3880	1160
KM-87	.875	.912	+ .003	.036		.019	.922		.031		.065		3920	1180
KM-90	.906	.943	- .003	.036		.019	.953		.031	+ .002	.065	± .004	4060	1220
KM-93	.938	.975		.036		.019	.986		.031	- .002	.065		4200	1260
KM-96	.968	1.011		.042		.021	1.022		.037		.075		5180	1440
KM-98	.987	1.030		.042		.021	1.041		.037		.075		5280	1470
KM-100	1.000	1.043		.042		.021	1.054		.037		.075		5350	1480
KM-102	1.023	1.066		.042		.021	1.078		.037		.075		5470	1520
KM-103	1.031	1.074		.042		.021	1.084		.037		.075		5510	1530
KM-106	1.062	1.104		.042		.021	1.117		.037		.075		5680	1580
KM-109	1.093	1.135		.042		.021	1.147		.037		.075		5840	1620
KM-112	1.125	1.167		.042		.021	1.180		.037		.075		6020	1670
KM-115	1.156	1.198		.042		.021	1.210		.037		.075		6180	1720
KM-118	1.188	1.236		.048		.024	1.249		.043		.085		7380	2020
KM-121	1.218	1.266		.048		.024	1.278		.043		.085		7570	2070
KM-125	1.250	1.298	+ .004	.048		.024	1.312		.043		.085		7770	2120
KM-128	1.281	1.329	- .004	.048		.024	1.342	+ .015	.043		.085		7960	2170
KM-131	1.312	1.360		.048	+ .004	.024	1.374	- .000	.043		.085		8150	2230
KM-134	1.343	1.395		.048	- .000	.026	1.408		.043		.085		8350	2470
KM-137	1.375	1.427		.048		.026	1.442		.043		.095		8540	2530
KM-140	1.406	1.458		.048		.026	1.472		.043		.095		8740	2580
KM-143	1.437	1.489		.048		.026	1.504		.043		.095		8930	2640
KM-145	1.456	1.508		.048		.026	1.523		.043		.095		9050	2680
KM-146	1.468	1.520		.048		.026	1.535		.043		.095		9120	2700
KM-150	1.500	1.552		.048		.026	1.567		.043		.095		9320	2760

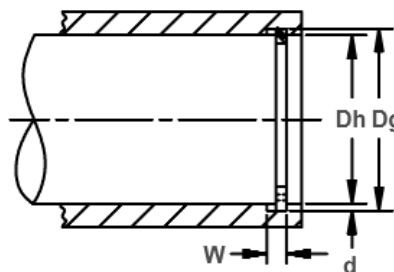
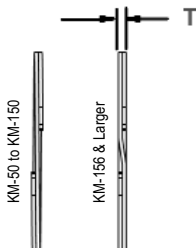
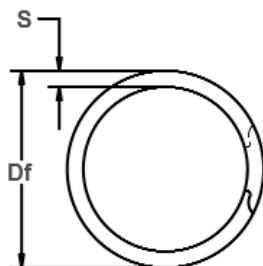

Free Diameter & Ring Measurements

Housing Diameter & Groove Dimensions

RING NO.	HOUSING DIAMETER	GROOVE SIZE					RING SIZE						THRUST LOAD (lbs.)	
		DIAMETER		WIDTH		DEPTH	FREE DIAMETER		THICKNESS		SECTION		RING Safety factor of 3	GROOVE Safety factor of 2
		(In.)	Dg	Tol.	W	Tol.	d	Df	Tol.	T	Tol.	S	Tol.	
KM-156	1.562	1.617	+ .005 - .005	.056	+ .004 - .000	.028	1.634	+ .020 - .000	.049	+ .025 - .000	.108	± .004	10100	3090
KM-157	1.574	1.633		.056		.030	1.649		.049		.108		10180	3340
KM-162	1.625	1.684		.056		.030	1.701		.049		.108		10510	3350
KM-165	1.653	1.712		.056		.030	1.730		.049		.108		10690	3510
KM-168	1.687	1.750		.056		.031	1.768		.049		.118		10910	3700
KM-175	1.750	1.813		.056		.031	1.834		.049		.118		11310	3840
KM-181	1.813	1.875		.056		.031	1.894		.049		.118		11720	3970
KM-185	1.850	1.917		.056		.034	1.937		.049		.118		11960	4450
KM-187	1.875	1.942		.056		.034	1.960		.049		.118		12120	4510
KM-193	1.938	2.005		.056		.034	2.025		.049		.118		12530	4660
KM-200	2.000	2.071	.056	.035	2.091	.049	.128	12930	4950					
KM-204	2.047	2.118	.056	.035	2.138	.049	.128	18240	5060					
KM-206	2.062	2.132	.056	.035	2.154	.049	.128	13330	5100					
KM-212	2.125	2.195	.056	.035	2.217	.049	.128	13740	5260					
KM-216	2.165	2.239	.056	.037	2.260	.049	.138	14000	5660					
KM-218	2.188	2.262	.056	.037	2.284	.049	.138	14150	5720					
KM-225	2.250	2.324	.056	.037	2.347	.049	.138	14550	5890					
KM-231	2.312	2.390	.056	.039	2.413	.049	.138	14950	6370					
KM-237	2.375	2.453	.056	.039	2.476	.049	.138	15360	6550					
KM-243	2.437	2.519	.056	.041	2.543	.049	.148	15760	7060					
KM-244	2.440	2.522	.056	.041	2.546	.049	.148	15780	7070					
KM-250	2.500	2.582	.056	.041	2.606	.049	.148	16160	7250					
KM-253	2.531	2.617	.056	.043	2.641	.049	.148	16360	7690					
KM-256	2.562	2.648	.056	.043	2.673	.049	.148	16560	7790					
KM-262	2.625	2.711	.056	.043	2.736	.049	.148	16970	7980					
KM-267	2.677	2.767	+ .006 - .006	.056	.045	2.789	.049	.158	17310	8520				
KM-268	2.688	2.778		.056	.045	2.803	.049	.158	17380	8550				
KM-275	2.750	2.841		.056	.045	2.865	.049	.158	17780	8750				
KM-281	2.813	2.903		.056	.045	2.929	.049	.158	18190	8950				
KM-283	2.834	2.928		.056	.047	2.954	.049	.168	18320	9520				
KM-287	2.875	2.969		.056	.047	2.995	.049	.168	18590	9550				
KM-293	2.937	3.031		.056	.047	3.058	.049	.168	18990	9760				
KM-295	2.952	3.046		.056	.047	3.073	.049	.168	19090	9810				
KM-300	3.000	3.096		.068	.048	3.122	.061	.168	24150	10180				
KM-306	3.062	3.158		.068	.048	3.186	.061	.168	24650	10390				
KM-312	3.125	3.223	.068	.048	3.251	.061	.178	25150	10600					
KM-314	3.149	3.247	.068	.048	3.276	.061	.178	25350	10680					
KM-318	3.187	3.283	.068	.048	3.311	.061	.178	25650	10810					
KM-325	3.250	3.350	.068	.050	3.379	.061	.178	26160	11490					
KM-331	3.312	3.416	.068	.052	3.446	.061	.188	26660	12170					
KM-334	3.346	3.450	.068	.052	3.479	.061	.188	26930	12300					
KM-337	3.375	3.479	.068	.052	3.509	.061	.188	27170	12410					

# KM Spiral Housing Rings

**Internal, Medium Duty**  
 These rings offer the greatest economy in price and size. They are able to handle approximately twice the thrust capacity of the KL series, and to be produced to military specifications if needed.

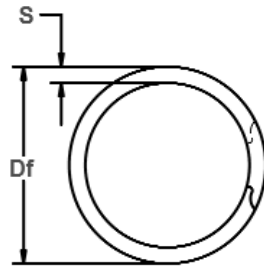

Free Diameter & Ring Measurements

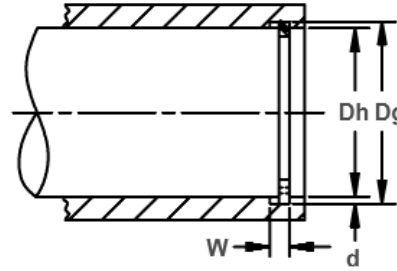
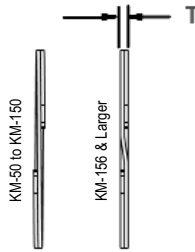

Housing Diameter & Groove Dimensions

RING NO.	HOUSING DIAMETER	GROOVE SIZE					RING SIZE					THRUST LOAD (lbs.)		
		DIAMETER		WIDTH		DEPTH	FREE DIAMETER		THICKNESS		SECTION		RING Safety factor of 3	GROOVE Safety factor of 2
		(In.)	Dg	Tol.	W	Tol.	d	Df	Tol.	T	Tol.	S	Tol.	
KM-343	3.437	3.543		.068		.053	3.574		.061		.188		27660	12880
KM-350	3.500	3.606		.068		.053	3.636		.061		.188		28170	13110
KM-354	3.543	3.653		.068		.055	3.684		.061		.198		28520	13770
KM-356	3.562	3.672		.068		.055	3.703		.061		.198		28670	13850
KM-362	3.625	3.737		.068		.056	3.769		.061		.198		29180	14350
KM-368	3.687	3.799		.068		.056	3.832	+ .030	.061		.198		29680	14600
KM-374	3.740	3.852		.068		.056	3.885	- .000	.061		.198		30100	14800
KM-375	3.750	3.862		.068		.056	3.894		.061	+ .003	.198		30180	14840
KM-381	3.812	3.930		.068		.059	3.963		.061	- .003	.208		30680	15900
KM-387	3.875	3.993		.068		.059	4.025		.061		.208		31190	16160
KM-393	3.938	4.056		.068		.059	4.089		.061		.208		31700	16420
KM-400	4.000	4.124		.068		.062	4.157		.061		.218		32200	17530
KM-406	4.063	4.187		.068		.062	4.222		.061		.218		32700	17810
KM-412	4.125	4.249	+ .006	.068		.062	4.284		.061		.218		33200	18080
KM-418	4.188	4.311	- .006	.068	+ .005	.062	4.347		.061		.218		33710	18350
KM-425	4.250	4.380		.068	- .000	.065	4.416		.061		.228		34210	19530
KM-431	4.312	4.442		.068		.065	4.479		.061		.228		34710	19810
KM-433	4.330	4.460		.068		.065	4.497		.061		.228		34850	19900
KM-437	4.375	4.505		.068		.065	4.543		.061		.228	+ .005	35210	20100
KM-443	4.437	4.573		.068		.068	4.611		.061		.238		35710	21330
KM-450	4.500	4.636		.068		.068	4.674		.061		.238		36220	21630
KM-452	4.527	4.663		.068		.068	4.701		.061		.238		36440	21760
KM-456	4.562	4.698		.068		.068	4.737	+ .035	.061		.238		36720	21930
KM-462	4.625	4.765		.079		.070	4.803	- .000	.072		.250		43940	22890
KM-468	4.687	4.827		.079		.070	4.867		.072		.250		44530	23190
KM-472	4.724	4.864		.079		.070	4.903		.072		.250		44880	23370
KM-475	4.750	4.890		.079		.070	4.930		.072		.250		45130	23500
KM-481	4.812	4.952		.079		.070	4.993		.072		.250		45720	23810
KM-487	4.875	5.015		.079		.070	5.055		.072		.250		46310	24120
KM-492	4.921	5.061		.079		.070	5.102		.072		.250		46750	24350
KM-493	4.937	5.081		.079		.072	5.122		.072	+ .004	.250		46900	25130
KM-500	5.000	5.144		.079		.072	5.185		.072	- .004	.250		47500	25450
KM-511	5.118	5.262		.079		.072	5.304		.072		.250		48620	26050
KM-512	5.125	5.269		.079		.072	5.311		.072		.250		48690	26100
KM-525	5.250	5.393		.079		.072	5.436		.072		.250		49880	26720
KM-537	5.375	5.522		.079		.074	5.566		.072		.250		51060	28120
KM-550	5.500	5.647	+ .007	.079		.074	5.693	+ .045	.072		.250		52250	28770
KM-551	5.511	5.658	- .007	.079		.074	5.703	- .000	.072		.250		52360	28830
KM-562	5.625	5.772		.079		.074	5.818		.072		.250		53440	29400
KM-570	5.708	5.861		.079		.077	5.909		.072		.250		54230	31070
KM-575	5.750	5.903		.079		.077	5.950		.072		.250		54630	31300

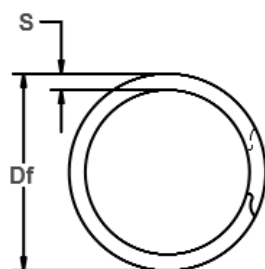

Free Diameter & Ring Measurements

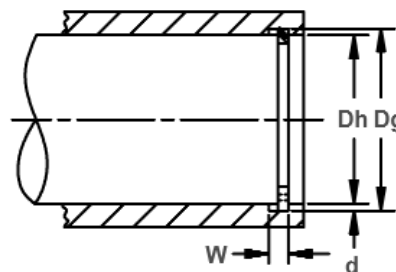
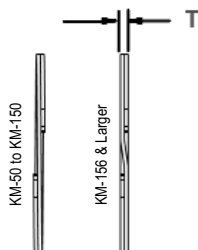

Housing Diameter & Groove Dimensions

RING NO.	HOUSING DIAMETER	GROOVE SIZE					RING SIZE					THRUST LOAD (lbs.)		
		DIAMETER		WIDTH		DEPTH	FREE DIAMETER		THICKNESS		SECTION		RING Safety factor of 3	GROOVE Safety factor of 2
		(In.)	Dg	Tol.	W	Tol.	d	Df	Tol.	T	Tol.	S	Tol.	
KM-587	5.875	6.028	+ .007	.079	+ .005	.077	6.077		.072		.250		55810	31980
KM-590	5.905	6.058	- .007	.079	- .005	.077	6.106	+ .045	.072		.250	± .005	56100	32140
KM-600	6.000	6.153		.079		.077	6.202	- .000	.072		.250		57000	32660
KM-612	6.125	6.297		.094		.086	6.349		.086		.312		69500	37200
KM-625	6.250	6.422		.094		.086	6.474		.086		.312		70920	37990
KM-629	6.299	6.471		.094		.086	6.524		.086		.312		71480	38290
KM-637	6.375	6.547		.094		.086	6.601		.086		.312		72340	38750
KM-650	6.500	6.672		.094		.086	6.726		.086		.312		73760	39510
KM-662	6.625	6.807		.094		.091	6.863	+ .055	.086		.312		75180	42620
KM-669	6.692	6.874		.094		.091	6.931	- .000	.086		.312		75940	43050
KM-675	6.750	6.932		.094		.091	6.987		.086		.312		76600	43420
KM-687	6.875	7.057		.094		.091	7.114		.086		.312		78010	44220
KM-700	7.000	7.182		.094		.091	7.239		.086		.312		79430	45030
KM-708	7.086	7.278		.094		.096	7.337		.086		.312		80410	48080
KM-712	7.125	7.317		.094		.096	7.376		.086		.312		80850	48350
KM-725	7.250	7.442		.094		.096	7.501		.086		.312		82270	49200
KM-737	7.375	7.567		.094		.096	7.628		.086		.312		83690	50050
KM-748	7.480	7.672		.094		.096	7.734		.086		.312		84880	50760
KM-750	7.500	7.692	+ .008	.094	+ .006	.096	7.754		.086		.312	± .006	85110	50890
KM-762	7.625	7.827	- .008	.094	- .006	.101	7.890		.086		.312		86520	54440
KM-775	7.750	7.952		.094		.101	8.014		.086	+ .004	.312		87940	55330
KM-787	7.875	8.077		.094		.101	8.141		.086	- .004	.312		89360	63360
KM-800	8.000	8.202		.094		.101	8.266		.086		.312		90780	57110
KM-825	8.250	8.462		.094		.106	8.528		.086		.375		93620	61820
KM-826	8.267	8.479		.094		.106	8.546		.086		.375		93810	61940
KM-846	8.464	8.676		.094		.106	8.744	+ .065	.086		.375		96050	63420
KM-850	8.500	8.712		.094		.106	8.780	- .000	.086		.375		96450	63690
KM-875	8.750	8.972		.094		.111	9.041		.086		.375		99290	68650
KM-885	8.858	9.080		.094		.111	9.151		.086		.375		100520	69500
KM-900	9.000	9.222		.094		.111	9.293		.086		.375		102130	70620
KM-905	9.055	9.287		.094		.116	9.359		.086		.375		102750	74250
KM-925	9.250	9.482		.094		.116	9.555		.086		.375		104960	75850
KM-944	9.448	9.680		.094		.116	9.755		.086		.375		107210	77470
KM-950	9.500	9.732		.094		.116	9.806		.086		.375		107800	77900
KM-975	9.750	9.992		.094		.121	10.068		.086		.375		110640	83390
KM-1000	10.000	10.242		.094		.121	10.320		.086		.375		113470	85530
KM-1025	10.250	10.502		.094		.126	10.582		.086		.375		116310	91290
KM-1050	10.500	10.752		.094		.126	10.834		.086		.375		119150	93520
KM-1075	10.750	11.012		.094		.131	11.095		.086		.375		121990	99540
KM-1100	11.000	11.262		.094		.131	11.347		.086		.375		124820	101860