

Power-Stud+ SD2 *Wedge Expansion Anchor*

PRODUCT DESCRIPTION

The Power-Stud+ SD2 anchor is a fully threaded, torque-controlled, wedge expansion anchor which is designed for consistent performance in cracked and uncracked concrete. Suitable base materials include normal-weight concrete, structural sand-lightweight concrete and concrete over steel deck. The anchor is manufactured with a zinc plated carbon steel body and stainless steel expansion clip for premium performance. Nut and washer are included.

GENERAL APPLICATIONS AND USES

- Structural connections, i.e., beam and column anchorage
- Safety-related attachments
- Interior applications / low level corrosion environment
- Tension zone applications, i.e., cable trays and strut, pipe supports, fire sprinklers
- Seismic and wind loading

FEATURES AND BENEFITS

- + Consistent performance in high and low strength concrete
- + Nominal drill bit size is the same as the anchor diameter
- + Anchor can be installed through standard fixture holes
- + Length ID code and identifying marking stamped on head of each anchor
- + Anchor design allows for follow-up expansion after setting under tensile loading

APPROVALS AND LISTINGS

International Code Council, Evaluation Service (ICC-ES), ESR-2502
 Code compliant with the 2006 IBC, 2006 IRC, 2003 IBC, 2003 IRC and 1997 UBC
 Tested in accordance with ACI 355.2 and ICC-ES AC193 for use in structural concrete under the design provisions of ACI 318 (Strength Design method using Appendix D)
 Evaluated and qualified by an accredited independent testing laboratory for recognition in cracked and uncracked concrete including seismic and wind loading (Category 1 anchors)
 FM Global (Factory Mutual) - File No. 3033795, 3/8" and 1/2" diameters
 Pipe hanger components for automatic sprinkler systems

GUIDE SPECIFICATIONS

CSI Divisions: 03151-Concrete Anchoring and 05090-Metal Fastenings.
 Expansion anchors shall be Power-Stud+ SD2 as supplied by Powers Fasteners, Inc., Brewster, NY.
 Anchors shall be installed in accordance with published instructions and the Authority Having Jurisdiction.

MATERIAL SPECIFICATIONS

Anchor component	Specification
Anchor body	Medium carbon steel
Hex nut	Carbon steel, ASTM A 563, Grade A
Washer	Carbon steel, ASTM F 844; meets dimensional requirements of ANSI B18.22.2, Type A Plain
Expansion wedge (clip)	Type 316 stainless steel
Plating (anchor body, nut and washer)	Zinc plating according to ASTM B 633, SC1, Type III (Fe/Zn 5) Minimum plating requirement for mild Service Condition

SECTION CONTENTS	Page No.
General Information	1
Material Specifications.....	1
Installation Specifications	2
Installation Instructions.....	3
Performance Data	4
Ordering Information	7



Power-Stud+ SD2 Assembly

THREAD VERSION

UNC threaded stud

ANCHOR MATERIALS

Zinc plated carbon steel body with stainless steel expansion clip, zinc plated carbon steel nut and washer

ANCHOR SIZE RANGE (TYP.)

3/8" diameter through 3/4" diameter

SUITABLE BASE MATERIALS

Normal-weight concrete
 Structural sand-lightweight concrete
 Concrete over steel deck



INSTALLATION SPECIFICATIONS

Installation Table for Power-Stud+ SD2

Anchor Property/Setting Information	Notation	Units	Nominal Anchor Size							
			3/8"	1/2"		5/8"		3/4"		
Anchor diameter	d_o	in. (mm)	0.375 (9.5)	0.500 (12.7)		0.625 (15.9)		0.750 (19.1)		
Minimum diameter of hole clearance in fixture	d_h	in. (mm)	7/16 (11.1)	9/16 (14.3)		11/16 (17.5)		13/16 (20.6)		
Nominal drill bit diameter	d_{bit}	in.	3/8 ANSI	1/2 ANSI		5/8 ANSI		3/4 ANSI		
Minimum nominal embedment depth	h_{nom}	in. (mm)	2-3/8 (60)	2-1/2 (64)	3-3/4 (95)	3-7/8 (98)	4-7/8 (124)	4-1/2 (114)	5-3/4 (146)	
Effective embedment	h_{ef}	in. (mm)	2 (51)	2 (51)	3-1/4 (83)	3-1/4 (83)	4-1/4 (108)	3-3/4 (95)	5 (127)	
Minimum hole depth ¹	h_o	in. (mm)	2-5/8 (67)	2-3/4 (70)	4 (102)	4-1/4 (108)	5-1/4 (133)	5 (127)	6-1/4 (159)	
Minimum concrete member thickness ¹	h_{min}	in. (mm)	4 (102)	4-1/2 (114)	5-3/4 (146)	5-3/4 (146)	6-1/2 (165)	7 (178)	10 (254)	
Minimum overall anchor length	ℓ_{anch}	in. (mm)	3 (76)	3-3/4 (95)	4-1/2 (114)	4-3/4 (121)	6 (152)	6-1/4 (159)	7 (178)	
Minimum edge distance ¹	c_{min}	in. (mm)	2-1/2 (64)	4 (102)	4 (102)	4-1/4 (108)	4-1/4 (108)	5 (127)	4-1/2 (114)	
Minimum spacing distance ¹	s_{min}	in. (mm)	3-1/2 (89)	6 (152)	4 (102)	4-1/4 (108)	4-1/4 (108)	6 (152)	6 (152)	
Critical edge distance ¹	c_{ac}	in. (mm)	8 (203)	8 (203)	10 (254)	8 (203)	15-3/4 (400)	12 (305)	12 (305)	
Installation torque	T_{inst}	ft.-lb. (N-m)	20 (27)	40 (54)		60 (81)		110 (149)		
Torque wrench socket size	-	in.	9/16	3/4		15/16		1-1/8		
Nut height	-	in.	21/64	7/16		35/64		41/64		

1. For installations through the soffit of steel deck into concrete, see the installation detail. Anchors in the lower flute may be installed with a maximum 1-inch offset in either direction from center of the flute. In addition, anchors shall have an axial spacing along the flute equal to the greater of $3h_{ef}$ or 1.5 times the flute width.

Power-Stud+ SD2 Anchor Detail

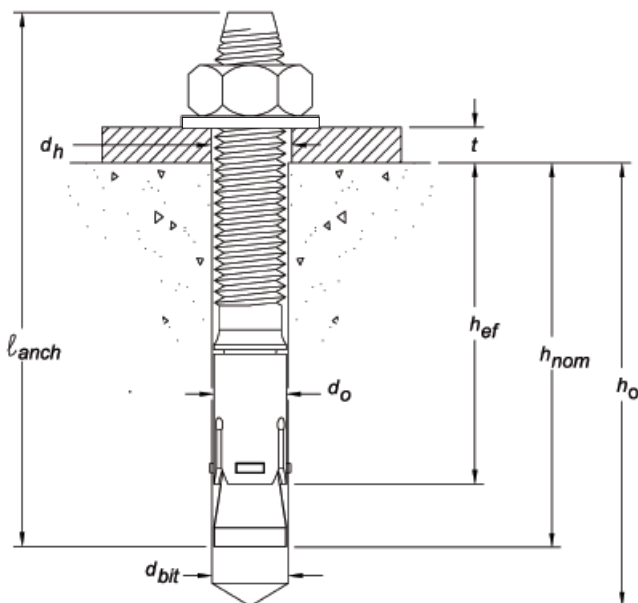

Head Marking



Legend

- Letter Code = Length Identification Mark
- '+' Symbol = Strength Design Compliant Anchor
- Number Code = Carbon Steel Body and Stainless Steel Expansion Clip

Length Identification

Mark	A	B	C	D	E	F	G	H
From	1-1/2"	2"	2-1/2"	3"	3-1/2"	4"	4-1/2"	5"
Up to but not including	2"	2-1/2"	3"	3-1/2"	4"	4-1/2"	5"	5-1/2"

Mark	I	J	K	L	M	N	O	P
From	5-1/2"	6"	6-1/2"	7"	7-1/2"	8"	8-1/2"	9"
Up to but not including	6"	6-1/2"	7"	7-1/2"	8"	8-1/2"	9"	9-1/2"

Length identification mark indicates overall length of anchor.

INSTALLATION INSTRUCTIONS

Installation Instructions for Power-Stud+ SD2

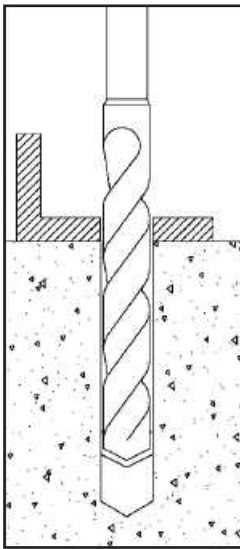

1.) Using the proper drill bit size, drill a hole into the base material to the required depth. The tolerances of the drill bit used should meet the requirements of ANSI Standard B212.15.

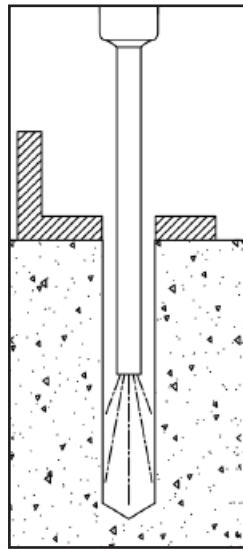

2.) Remove dust and debris from the hole.

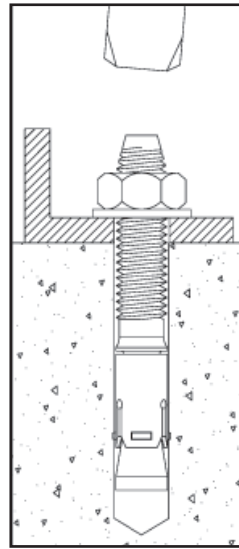

3.) Position the washer on the anchor and thread on the nut. If installing through a fixture, drive the anchor through the fixture into the hole. Be sure the anchor is driven to the minimum required nominal embedment depth, h_{nom} .

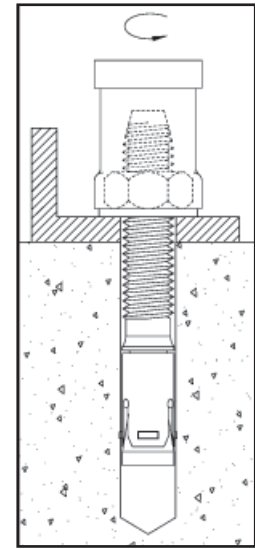

4.) Tighten the anchor with a torque wrench by applying the required installation torque, T_{inst} .

Installation Detail for Power-Stud+ SD2 Installed Through Soffit of Steel Deck into Concrete

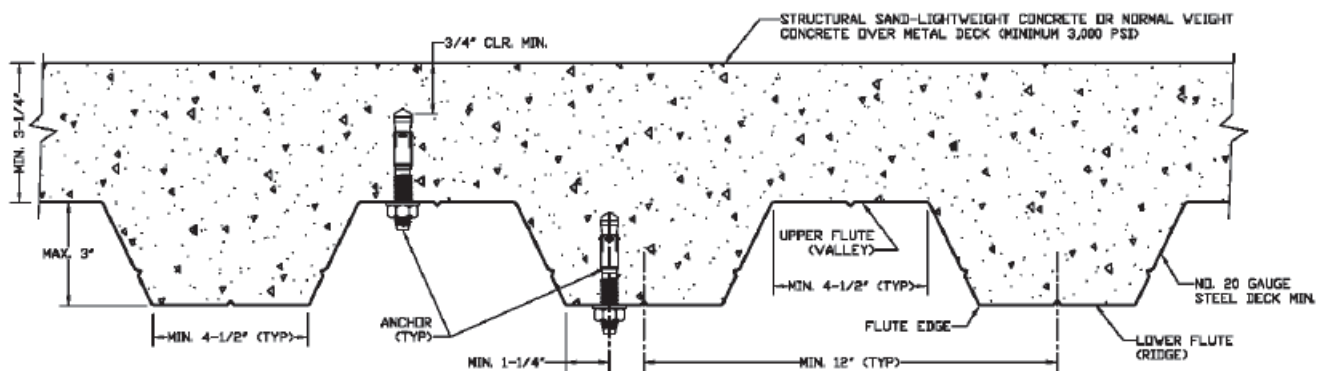

PERFORMANCE DATA

Tension Design Information (For use with load combinations taken from ACI 318 Section 9.2)^{1,2,3}

Design Characteristic	Notation	Units	Nominal Anchor Size						
			3/8"	1/2"		5/8"		3/4"	
Anchor category	1, 2 or 3	-	1	1		1		1	
Nominal embedment depth	h_{nom}	in.	2-3/8	2-1/2	3-3/4	3-7/8	4-7/8	4-1/2	5-3/4
STEEL STRENGTH IN TENSION⁴									
Minimum specified yield strength (neck)	f_y	ksi (N/mm ²)	96.0 (662)	85.0 (586)		85.0 (586)		70.0 (483)	
Minimum specified ultimate strength (neck)	f_{uta}	ksi (N/mm ²)	120.0 (827)	106.0 (731)		106.0 (731)		90.0 (620)	
Effective tensile stress area (neck)	A_{se}	in ² (mm ²)	0.0552 (35.6)	0.1007 (65.0)		0.1619 (104.5)		0.2359 (153.2)	
Steel strength in tension	N_{sa}	lb (kN)	6,625 (29.4)	10,445 (48.0)		13,080 (58.2)		21,230 (94.4)	
Reduction factor for steel strength ³	ϕ	-	0.75						
CONCRETE BREAKOUT STRENGTH IN TENSION⁸									
Effective embedment	h_{ef}	in. (mm)	2.00 (51)	2.00 (51)	3.25 (83)	3.25 (83)	4.25 (108)	3.75 (95)	5.00 (127)
Effectiveness factor for uncracked concrete	k_{uncr}	-	24	24		24		24	
Effectiveness factor for cracked concrete	k_{cr}	-	17	17		17		17	
Modification factor for cracked and uncracked concrete ⁵	$\psi_{c,N}$	-	1.0 See note 5	1.0 See note 5		1.0 See note 5		1.0 See note 5	
Critical edge distance	c_{ac}	in. (mm)	8 (203)	8 (203)	10 (254)	8 (203)	15-3/4 (400)	12 (305)	12 (305)
Reduction factor for concrete breakout strength ³	ϕ	-	0.65 (Condition B)						
PULLOUT STRENGTH IN TENSION (NON-SEISMIC APPLICATIONS)⁸									
Characteristic pullout strength, uncracked concrete (2,500 psi) ⁶	$N_{p,uncr}$	lb (kN)	2,775 (12.3)	See note 7	6,615 (29.4)	See note 7	See note 7	See note 7	See note 7
Characteristic pullout strength, cracked concrete (2,500 psi) ⁶	$N_{p,cr}$	lb (kN)	2,165 (9.6)	See note 7	4,375 (19.5)	See note 7	4,980 (22.4)	See note 7	7,795 (35.1)
Reduction factor for pullout strength ³	ϕ	-	0.65 (Condition B)						
PULLOUT STRENGTH IN TENSION FOR SEISMIC APPLICATIONS⁸									
Characteristic pullout strength, seismic ^{6,9}	$N_{p,eq}$ ($N_{p,seis}$)	lb (kN)	2,165 (9.6)	See note 7	4,375 (19.5)	See note 7	4,980 (22.4)	See note 7	7,795 (35.1)
Reduction factor for pullout strength ³	ϕ	-	0.65 (Condition B)						
PULLOUT STRENGTH IN TENSION FOR STRUCTURAL SAND-LIGHTWEIGHT AND NORMAL-WEIGHT CONCRETE OVER STEEL DECK									
Characteristic pullout strength, uncracked concrete over steel deck ¹⁰	$N_{p,deck,uncr}$	lb (kN)	1,855 (8.3)	2,065 (9.2)	3,930 (17.5)	4,665 (20.8)	7,365 (32.8)	4,900 (21.8)	4,900 (21.8)
Characteristic pullout strength, cracked concrete over steel deck ¹⁰	$N_{p,deck,cr}$	lb (kN)	1,445 (6.4)	1,465 (6.5)	2,600 (11.6)	3,305 (14.7)	3,490 (15.5)	3,470 (15.4)	3,470 (15.4)
Reduction factor for pullout strength ³	ϕ	-	0.65 (Condition B)						

- The data in this table is intended to be used with the design provisions of ACI 318 Appendix D; for anchors resisting seismic load combinations the additional requirements of Section D.3.3 shall apply.
- Installation must comply with published instructions and details.
- All values of ϕ were determined from the load combinations of ACI 318 Section 9.2. If the load combinations of Appendix C are used, the appropriate value of ϕ must be determined in accordance with ACI 318 Section D.4.5. For reinforcement that meets ACI 318 Appendix D requirements for Condition A, see ACI 318 Section D.4.4 for the appropriate ϕ factor.
- The Power-Stud+ SD2 is considered a ductile steel element in tension as defined by ACI 318 Section D.1. Reported values for steel strength in tension are based on test results per ACI 355.2 and shall be used for design.
- For all design cases use $\psi_{c,N} = 1.0$. Select appropriate effectiveness factor for cracked concrete (k_{cr}) or uncracked concrete (k_{uncr}).
- For all design cases use $\psi_{c,P} = 1.0$. For concrete compressive strength greater than 2,500 psi, $N_{pn} = (\text{pullout strength value from table}) * (\text{specified concrete compressive strength} / 2500)^n$.
For all anchors $n = 1/2$ with the exception of the 3/8" anchor size for cracked concrete where $n = 1/3$.
- Pullout strength will not control design of indicated anchors. Do not calculate pullout strength for indicated anchor size and embedment.
- Anchors are permitted to be used in structural sand-lightweight concrete provided that N_p and N_{pn} are multiplied by a factor of 0.60 (not required for steel deck).
- Reported values for characteristic pullout strength in tension for seismic applications are based on test results per ACI 355.2, Section 9.5.
- Values for $N_{p,deck}$ are for structural sand-lightweight concrete ($f'_{c,min} = 3,000$ psi) and additional lightweight concrete reduction factors need not be applied. In addition, evaluation for the concrete breakout capacity in accordance with ACI 318 Section D.5.2 is not required for anchors installed in the flute (soffit).

PERFORMANCE DATA**Shear Design Information (For use with load combinations taken from ACI 318 Section 9.2)^{1,2}**

Design Characteristic	Notation	Units	Nominal Anchor Size						
			3/8"	1/2"		5/8"		3/4"	
Anchor category	1, 2 or 3	-	1	1		1		1	
Nominal embedment depth	h_{nom}	in.	2-3/8	2-1/2	3-3/4	3-7/8	4-7/8	4-1/2	5-3/4
STEEL STRENGTH IN SHEAR⁴									
Minimum specified yield strength (threads)	f_y	ksi (N/mm ²)	76.8 (530)	68.0 (469)		68.0 (469)		56.0 (386)	
Minimum specified ultimate strength (threads)	f_{uta}	ksi (N/mm ²)	96.0 (662)	84.8 (585)		84.8 (585)		72.0 (496)	
Effective tensile stress area (threads)	A_{se}	in ² (mm ²)	0.0775 (50.0)	0.1419 (65.7)		0.2260 (104.9)		0.3345 (215.8)	
Steel strength in shear ⁵	V_{sa}	lb (kN)	2,190 (9.7)	4,640 (20.6)		9,800 (44.1)		10,175 (45.3)	
Reduction factor for steel strength ³	ϕ	-	0.60		0.65				
CONCRETE BREAKOUT STRENGTH IN SHEAR⁶									
Load bearing length of anchor (h_{ef} or $8d_o$, whichever is less)	l_e	in. (mm)	2.00 (51)	2.00 (51)	3.25 (83)	3.25 (83)	4.25 (108)	3.75 (95)	5.00 (127)
Reduction factor for concrete breakout strength ³	ϕ	-	0.70 (Condition B)						
CONCRETE PRYOUT STRENGTH IN SHEAR⁶									
Coefficient for prout strength (1.0 for $h_{ef} < 2.5$ in., 2.0 for $h_{ef} \geq 2.5$ in.)	k_{cp}	-	1.0	1.0	2.0	2.0	2.0	2.0	2.0
Effective embedment	h_{ef}	in. (mm)	2.00 (51)	2.00 (51)	3.25 (83)	3.25 (83)	4.25 (108)	3.75 (95)	5.00 (127)
Reduction factor for prout strength ³	ϕ	-	0.70 (Condition B)						
STEEL STRENGTH IN SHEAR FOR SEISMIC APPLICATIONS⁶									
Steel strength in shear, seismic ⁷	$V_{sa,seis}$	lb (kN)	1,955 (8.7)	4,640 (20.6)		6,530 (29.0)		6,635 (29.5)	
Reduction factor for steel strength in shear, seismic ³	ϕ	-	0.60		0.65				
STEEL STRENGTH IN SHEAR FOR STRUCTURAL SAND-LIGHTWEIGHT AND NORMAL-WEIGHT CONCRETE OVER STEEL DECK⁹									
Steel strength in shear, concrete over steel deck ⁸	$V_{sa,deck}$	lb (kN)	2,170 (9.7)	3,815 (17.0)	5,040 (22.4)	4,015 (17.9)	6,670 (29.7)	4,325 (19.2)	4,325 (19.2)
Reduction factor for steel strength in shear for concrete over steel deck ³	ϕ	-	0.60		0.65				

- The data in this table is intended to be used with the design provisions of ACI 318 Appendix D; for anchors resisting seismic load combinations the additional requirements of Section D.3.3 shall apply.
- Installation must comply with published instructions and details.
- All values of ϕ were determined from the load combinations of ACI 318 Section 9.2. If the load combinations of Appendix C are used, the appropriate value of ϕ must be determined in accordance with ACI 318 Section D.4.5. For reinforcement that meets ACI 318 Appendix D requirements for Condition A, see ACI 318 Section D.4.4 for the appropriate ϕ factor.
- The Power-Stud+ SD2 is considered a ductile steel element as defined by ACI 318 Section D.1 with the exception of the 3/8" anchor size in shear.
- Reported values for steel strength in shear are based on test results per ACI 355.2, Section 9.4 and shall be used for design. These reported values may be lower than calculated results using equation D-20 in ACI 318-05 Section D.6.1.2 and D-18 in ACI 318-02, Section D.6.1.2.
- Anchors are permitted to be used in structural sand-lightweight concrete provided that V_b and V_{cp} are multiplied by a factor of 0.60 (not required for steel deck).
- Reported values for steel strength in shear for seismic applications are based on test results per ACI 355.2, Section 9.6.
- Values for $V_{sa,deck}$ are for structural sand-lightweight concrete ($f'_c \text{ min} = 3,000$ psi) and additional lightweight concrete reduction factors need not be applied. In addition, evaluation for the concrete breakout capacity in accordance with ACI 318 Section D.6.2 and the prout capacity in accordance with Section D.6.3 are not required for anchors installed in the flute (soffit).
- Shear loads for anchors installed through steel deck into concrete may be applied in any direction.

(e)

Factored Design Strength (ϕN_n and ϕV_n) Calculated in Accordance with ACI 318 Appendix D:

- Tabular values are provided for illustration and are applicable for single anchors installed in normal-weight concrete with minimum slab thickness, $h_a = h_{min}$, and with the following conditions:
 - c_{a1} is greater than or equal to the critical edge distance, c_{ac} (table values based on $c_{a1} = c_{ac}$).
 - c_{a2} is greater than or equal to $1.5 c_{a1}$.
- Calculations were performed according to ACI 318-05 Appendix D. The load level corresponding to the controlling failure mode is listed (e.g. For *tension*: steel, concrete breakout and pullout; For *shear*: steel, concrete breakout and pryout). Furthermore, the capacities for concrete breakout strength in tension and pryout strength in shear are calculated using the effective embedment values, h_{ef} , for the selected anchors as noted in the design information tables. Please also reference the installation specifications for more information.
- Strength reduction factors (ϕ) were based on ACI 318 Section 9.2 for load combinations. Condition B is assumed.
- Tabular values are permitted for static loads only, seismic loading is not permitted with these tables.
- For designs that include combined tension and shear, the interaction of tension and shear loads must be calculated in accordance with ACI 318 Appendix D.
- Interpolation is not permitted to be used with the tabular values. For intermediate base material compressive strengths please see ACI 318 Appendix D. For other design conditions including seismic considerations please see ACI 318 Appendix D.

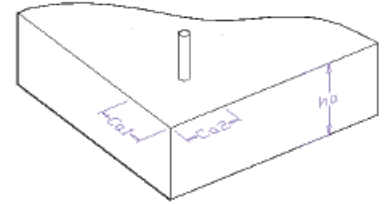

Tension and Shear Factored Design Strength for Power-Stud+ SD2 in Cracked Concrete

Nominal Anchor Size (in.)	Nominal Embed. h_{nom} (in.)	Minimum Concrete Compressive Strength, f'_c (psi)									
		2,500		3,000		4,000		6,000		8,000	
		ϕN_n Tension (lbs.)	ϕV_n Shear (lbs.)	ϕN_n Tension (lbs.)	ϕV_n Shear (lbs.)	ϕN_n Tension (lbs.)	ϕV_n Shear (lbs.)	ϕN_n Tension (lbs.)	ϕV_n Shear (lbs.)	ϕN_n Tension (lbs.)	ϕV_n Shear (lbs.)
3/8	2-3/8	1,405	1,315	1,495	1,315	1,645	1,315	1,885	1,315	2,075	1,315
1/2	2-1/2	1,565	1,685	1,710	1,845	1,975	2,130	2,420	2,605	2,795	3,010
	3-3/4	2,845	3,015	3,115	3,015	3,595	3,015	4,405	3,015	5,085	3,015
5/8	3-7/8	3,235	3,575	3,545	3,920	4,095	4,525	5,015	5,540	5,790	6,370
	4-7/8	3,235	4,885	3,545	5,355	4,095	6,180	5,015	6,370	5,790	6,370
3/4	4-1/2	4,010	4,730	4,395	5,185	5,075	5,985	6,215	6,615	7,175	6,615
	5-3/4	5,065	6,615	5,550	6,615	6,410	6,615	7,850	6,615	9,065	6,615

Tension and Shear Factored Design Strength for Power-Stud+ SD2 in Uncracked Concrete

Nominal Anchor Size (in.)	Nominal Embed. h_{nom} (in.)	Minimum Concrete Compressive Strength, f'_c (psi)									
		2,500		3,000		4,000		6,000		8,000	
		ϕN_n Tension (lbs.)	ϕV_n Shear (lbs.)	ϕN_n Tension (lbs.)	ϕV_n Shear (lbs.)	ϕN_n Tension (lbs.)	ϕV_n Shear (lbs.)	ϕN_n Tension (lbs.)	ϕV_n Shear (lbs.)	ϕN_n Tension (lbs.)	ϕV_n Shear (lbs.)
3/8	2-3/8	1,805	1,315	1,975	1,315	2,280	1,315	2,795	1,315	3,225	1,315
1/2	2-1/2	2,205	2,375	2,415	2,605	2,790	3,005	2,795	3,015	3,945	3,015
	3-3/4	4,300	3,015	4,710	3,015	5,440	3,015	6,660	3,015	7,690	3,015
5/8	3-7/8	4,570	5,005	5,005	5,485	5,780	6,335	7,080	6,370	8,175	6,370
	4-7/8	6,835	6,370	7,485	6,370	8,645	6,370	10,585	6,370	12,225	6,370
3/4	4-1/2	5,665	6,615	6,205	6,615	7,165	6,615	8,775	6,615	10,130	6,615
	5-3/4	8,720	6,615	9,555	6,615	11,030	6,615	13,510	6,615	15,600	6,615

Legend

- Steel Strength Controls
- Concrete Breakout Strength Controls
- Anchor Pullout/Pryout Strength Controls

ORDERING INFORMATION

Power-Stud+ SD2 (Carbon Steel Body with Stainless Steel Expansion Clip)



Cat. No.	Anchor Size	Min. Nominal Embed.	Thread Length	Box Qty.	Carton Qty.	Wt./100 (lbs)
7413SD2	3/8" x 3"	2-3/8"	1-3/4"	50	300	10
7414SD2	3/8" x 3-1/2"	2-3/8"	2-1/4"	50	300	12
7415SD2	3/8" x 3-3/4"	2-3/8"	2-1/2"	50	300	13
7416SD2	3/8" x 5"	2-3/8"	3-3/4"	50	300	16
7422SD2	1/2" x 3-3/4"	2-1/2"	2-1/8"	50	200	23
7423SD2	1/2" x 4-1/2"	2-1/2"	2-7/8"	50	200	28
7424SD2	1/2" x 5-1/2"	2-1/2"	3-7/8"	50	150	32
7426SD2	1/2" x 7"	2-1/2"	5-3/8"	25	100	44
7427SD2	1/2" x 8-1/2"	2-1/2"	6-7/8"	25	100	46
7435SD2	5/8" x 4-3/4"	3-7/8"	2-7/8"	25	100	52
7433SD2	5/8" x 5"	3-7/8"	3-1/8"	25	100	57
7434SD2	5/8" x 6"	3-7/8"	4-1/8"	25	75	64
7436SD2	5/8" x 7"	3-7/8"	5-1/8"	25	75	72
7438SD2	5/8" x 8-1/2"	3-7/8"	6-5/8"	25	75	84
7442SD2	3/4" x 5-1/2"	4-1/2"	3-1/4"	20	60	88
7444SD2	3/4" x 6-1/4"	4-1/2"	4"	20	60	90
7446SD2	3/4" x 7"	4-1/2"	4-3/4"	20	60	95
7448SD2	3/4" x 8-1/2"	4-1/2"	6-1/4"	10	60	95

The published size includes the diameter and the overall length of the anchor.
All anchors are packaged with nuts and washers.

Installation Accessories

Cat. No.	Description	Box Qty.
08465	Adjustable torque wrench with 1/2" square drive (10 to 150 ft.-lbs.)	1
08280	Hand pump / dust blower	1

